



# Metropolis Basin



U.S. Design Patent 433743

**Model Shown Above:**  
**Model 8930** (D Shaped Bowl) shown with -H36 Faucet Configuration  
**Model 8931-RLL** (Large Round Bowl) -H0 Faucet Configuration only  
**Model 8931-RLS** (Small Round Bowl) shown with -H1 Faucet Configuration

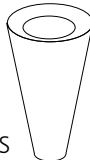
- **ONE PIECE CONICAL PEDESTAL WASH BASIN**
  - **Heavy 16-Gage Stainless Steel Construction**
  - **Three Finishes Available**
    - Satin Finish (entire unit)
    - Mira Finish Rim (Satin Finish Fixture/Mira Rim)
    - Mira High Polish Finish - All (entire unit)
  - **Three Bowl Options Available**
    - D Shaped Bowl
    - Large Round Bowl (15-3/4" Diameter)
    - Small Round Bowl (11-1/2" Diameter)
  - **Concealed Access Panel**
- NOTE: Faucet is Sold Separately**

DESCRIPTION	MODEL/OPTION #
<b>METROPOLIS BASIN - D BOWL</b> INIT.	
<input type="checkbox"/> <b>Satin Finish</b> Entire Fixture is in Satin Finish	8930-S
<input type="checkbox"/> <b>Mira Finish Rim</b> Satin Finish Fixture with Mira High Polish Rim	8930-HPR
<input type="checkbox"/> <b>Mira Finish - All</b> Entire Fixture is in Mira High Polish Finish	8930-HPA
<b>FAUCET CONFIGURATION</b>	
<input type="checkbox"/> <b>Single Hole</b>	- H1
Neo-Metro Deck Mounted Faucet is available for this Metropolis Basin (Sold Separately)	
<input type="checkbox"/> -NMF-2-S (Satin Finish)	<input type="checkbox"/> - NMF-2-HP (Mira High Polish)
<input type="checkbox"/> <b>6" (152 mm) Center Set</b>	- H36
<input type="checkbox"/> <b>Less Punching</b>	- H0 (Requires Wall Mounted Faucet)
<b>BOWL OVERFLOW OPTION</b>	
<input type="checkbox"/> <b>Overflow Outlet</b>	- OF
<b>METROPOLIS BASIN - LARGE ROUND BOWL</b> INIT.	
<b>15-3/4" (400 mm) Round Inner Bowl</b>	
<input type="checkbox"/> <b>Satin Finish</b> Entire Fixture is in Satin Finish	8931-RLL-S
<input type="checkbox"/> <b>Mira Finish Rim</b> Satin Finish Fixture with Mira High Polish Rim	8931-RLL-HPR
<input type="checkbox"/> <b>Mira Finish - All</b> Entire Fixture is in Mira High Polish Finish	8931-RLL-HPA
<b>FAUCET CONFIGURATION</b>	
<input type="checkbox"/> <b>Less Punching</b>	- H0 (Requires Wall Mounted Faucet; This is the only option for this Metropolis Basin.)
<b>BOWL OVERFLOW OPTION</b>	
<input type="checkbox"/> <b>Overflow Outlet</b>	- OF
 Model 8931-RLS	
	



Neo-Metro is a Member of U.S. Green Building Council



# Metropolis Basin



**Model 8931-RLS**

U.S. Design Patent 433743

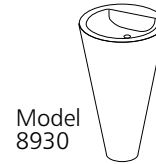

DESCRIPTION	MODEL/OPTION #
<b>METROPOLIS BASIN - SMALL ROUND BOWL</b>	INIT. _____

**11-1/2" (292 mm) Round Inner Bowl**

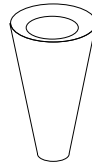

- Satin Finish** 8931-RLS-S  
Entire Fixture is in Satin Finish
- Mira Finish Rim** 8931-RLS-HPR  
Satin Finish Fixture with Mira High Polish Rim
- Mira Finish - All** 8931-RLS-HPA  
Entire Fixture is in Mira High Polish Finish

**FAUCET CONFIGURATION**



- Single Hole** - H1

Neo-Metro Deck Mounted Faucet is available for this Metropolis Basin (Sold Separately)



- NMF-2-S (Satin Finish)
- NMF-2-HP (Mira High Polish)



- Less Punching** - H0  
(Requires Wall Mounted Faucet)



- BOWL OVERFLOW OPTION**
- Overflow Outlet** - OF



**APPROVAL FOR MANUFACTURE**

COMPANY: \_\_\_\_\_

PROJECT NAME: \_\_\_\_\_

SIGNEE'S NAME WRITTEN CLEARLY: \_\_\_\_\_

DATE \_\_\_\_\_

AUTHORIZED SIGNATURE: \_\_\_\_\_

# Metropolis Basin

**PRODUCT Specification . . .** Neo-Metro's patented (U.S. Design Patent 433743) conical shaped pedestal basin shall be manufactured entirely of 16-gage, type 304 stainless steel, with seam welded construction. Basin shall have a 1-1/2" (38mm) diameter drain opening for standard drain fitting. Basin shall be available with a 'D' shaped bowl (8930), a large 15-3/4" (400mm) round bowl (8931-RLL) or a small 11-1/2" (290mm) round bowl (8931-RLS). The fixture is available completely in a Satin Finish (-S), Satin Finish with a Mira (high polish) rim (-HPR), or completely in Mira Finish (-HPA). Customer

must also specify faucet mounting preference. A single hole faucet is available separately through Neo-Metro.

**PLUMBING Specification . . .** Basin shall be wall mounted and supported on floor. Concealed rear panel provides access to drain and P-trap (p-trap by others). 'D' Basin (8930) and 11-1/2" Round Basin (8931-RLS) can be factory punched with single hole or 6" (152 mm) center set (customer must specify at time of ordering). Holes punched for faucets are 1-5/16" (33 mm) diameter. The basin can be manufactured with an overflow outlet.

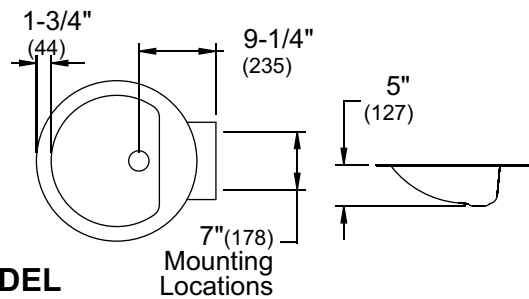
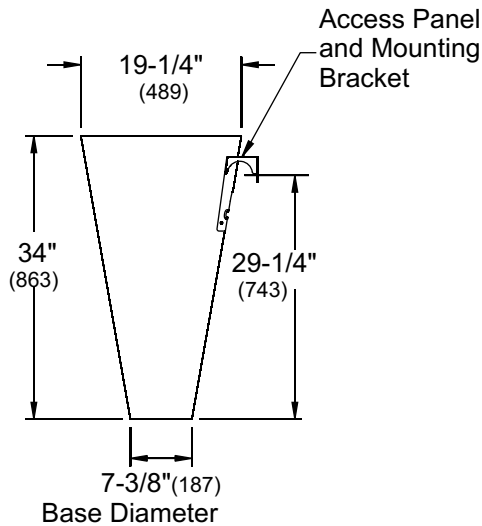

**MODEL 8930-H0**

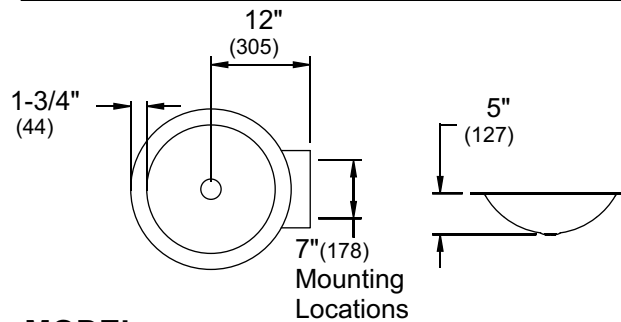

**MODEL 8931-RLL-H0**

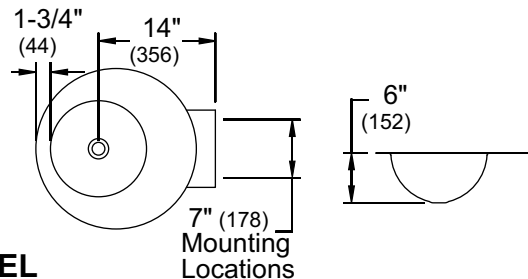

**MODEL 8931-RLS-H0**

Neo-Metro assumes no responsibility for use of void or suspended data. All dimensions are nominal and subject to manufacturer change without notice.

**INSTALLATION INSTRUCTIONS ARE AVAILABLE**